

S4021 June
 WASSCE 2013
 GENERAL MATHEMATICS/
 MATHEMATICS (CORE) 1
 Objective Test
 1 1/2 hours

Name: Heaton Alamine
 Index Number: 208100227

THE WEST AFRICAN EXAMINATIONS COUNCIL
 West African Senior School Certificate Examination

June 2013 GENERAL MATHEMATICS/MATHEMATICS (CORE) 1 1 1/2 hours
 OBJECTIVE TEST
 [50 marks]

Do not open this booklet until you are told to do so. While you are waiting, write your name and index number in the spaces provided at the top right-hand corner of this booklet and thereafter, read the following instructions carefully.

- Use HB pencil throughout.
- If you have got a blank answer sheet, complete its top section as follows.
 - In the space marked *Name*, write in capital letters your **surname** followed by your **other names**.
 - In the spaces marked *Examination*, *Year*, *Subject* and *Paper*, write 'WASSCE', '2013 JUNE', 'GENERAL MATHEMATICS/MATHEMATICS (CORE)' and '1', respectively.
 - In the box marked *Index Number*, write your **index number** vertically in the spaces on the left-hand side. There are numbered spaces in line with each digit. Shade carefully the space with the same number as each digit.
 - In the box marked *Paper Code*, write the digits 402112 in the spaces on the left-hand side. Shade the corresponding numbered spaces in the same way as for your index number.
 - In the box marked *Sex*, shade the space marked M if you are male, or F if you are female.
- If you have got a pre-printed answer sheet, check that the details are correctly printed, as described in 2 above. In the boxes marked *Index Number*, *Paper Code* and *Sex*, reshade each of the shaded spaces.
- An example is given below. This is for a male candidate, whose name is Chukwuma Adekunle CIROMA, whose index number is 4251102068 and who is offering General Mathematics/Mathematics (Core) 1.

THE WEST AFRICAN EXAMINATIONS COUNCIL

PRINT IN BLOCK LETTERS

Name: CIROMA CHUKWUMA ADEKUNLE Examination: WASSCE Year: 2013 JUNE
Surname Other Names

Subject: GENERAL MATHEMATICS / MATHEMATICS (CORE) Paper: 1

INDEX NUMBER		PAPER CODE		SEX
4	0	4	0	Indicate your sex by shading the space marked M (for Male) or F (for Female) in this box: M <input type="checkbox"/> F <input type="checkbox"/>
2	0	0	0	
5	0	2	0	
1	0	1	0	
1	0	1	0	
0	0	1	0	
2	0	2	0	
0	0	2	0	
6	0	INSTRUCTIONS TO CANDIDATES 1. Use grade HB pencil throughout. 2. Answer each question by choosing one letter and shading it like this: [A] [B] [C] <input checked="" type="checkbox"/> 3. Erase completely any answers you wish to change. 4. Leave extra spaces blank if the answer spaces provided are more than you need. 5. Do not make any markings across the heavy black marks at the right-hand edge of your answer sheet.		
8	0			

For Supervisors only.
 If candidate is absent shade this space:

Answer **all** the questions.

Mathematical tables may be used in any question.

The use of non-programmable, silent and cordless calculator is allowed.

Each question is followed by four options lettered A to D. Find out the correct option for each question and shade in pencil on your answer sheet the answer space which bears the same letter as the option you have chosen. Give only one answer to each question. An example is given below.

The ages, in years, of four boys are 10, 12, 14, and 18. What is the average age of the boys?

- A. 12 years
- B. $12\frac{1}{2}$ years
- C. 13 years
- D. $13\frac{1}{2}$ years

The correct answer is $13\frac{1}{2}$ years, which is lettered D, and therefore answer space D would be shaded.

[A]

[B]

[C]

Think carefully before you shade the answer spaces; erase completely any answer you wish to change.

Do all rough work on this question paper.

Now, answer the following questions.

1. Multiply 2.7×10^{-4} by 6.3×10^6 and leave your answer in standard form.

- A. 1.7×10^3
- B. 1.70×10^3
- C. 1.701×10^3
- D. 17.01×10^3

2. If $9^{(2-x)} = 3$, find x .

- A. 1
- B. $\frac{3}{2}$
- C. 2
- D. $\frac{5}{2}$

3. In what number base is the addition $465 + 24 + 225 = 1050$?

- A. ten
- B. nine
- C. eight
- D. seven

$$\begin{array}{r}
 4 \frac{20}{40} \\
 40 \overline{)180} \\
 \underline{160} \\
 20
 \end{array}$$

4. Simplify: $\frac{1\frac{7}{8} \times 2\frac{2}{5}}{6\frac{3}{4} \div \frac{3}{4}} = \frac{15}{8} \times \frac{12}{5} = \frac{180}{40} = 40 \overline{)180} = 4\frac{5}{40} = 4\frac{20}{40} = 4\frac{1}{2}$

- A. 9
- B. $4\frac{1}{2}$
- C. 2
- D. $\frac{1}{2}$

$$\frac{27}{4} \div \frac{3}{4} = \frac{27}{4} \times \frac{4}{3} = \frac{108}{12} = 9$$

$$\frac{4\frac{1}{2}}{9} = 9 \div 9 = 1$$

5. If $U_n = n(n^2 + 1)$, evaluate $U_5 - U_4$.

- A. 18
- B. 56
- C. 62
- D. 80

$$\frac{9}{1} \div \frac{9}{1} = \frac{9}{2} \div \frac{9}{1}$$

$$\frac{9}{2} \times \frac{1}{9} = \frac{9}{18} = \frac{1}{2}$$

6. If $\sqrt{50} - K\sqrt{8} = \frac{2}{\sqrt{2}}$, find K.

- A. -2
- B. -1
- C. 1
- D. 2

7. A sales boy gave a change of N68 instead of N72. Calculate his percentage error.

- A. 4%
- B. $5\frac{5}{9}\%$
- C. $5\frac{15}{17}\%$
- D. 7%

Turn over

8. Four oranges sell for Nx and three mangoes sell for Ny . Olu bought 24 oranges and 12 mangoes. How much did he pay in terms of x and y ?

- A. $N(4x + 6y)$
- B. $N(6x + 4y)$
- C. $N(24x + 12y)$
- D. $N(12x + 24y)$

9. Simplify: $\frac{x^2 - y^2}{(x + y)^2} \div \frac{(x - y)^2}{(3x + 3y)}$

$$\frac{x^2 - y^2}{(x + y)^2} \times \frac{(3x + 3y)}{(x - y)^2}$$

- A. $\frac{x - y}{3}$
- B. $x + y$
- C. $\frac{3}{x - y}$
- D. $x - y$

$3x + 3y$

10. Solve the inequality: $\frac{2x - 5}{2} < (2 - x)$.

- A. $x > 0$
- B. $x < \frac{1}{4}$
- C. $x > 2\frac{1}{2}$
- D. $x < 2\frac{1}{4}$

11. If $x = 64$ and $y = 27$, evaluate: $\frac{x^{\frac{1}{2}} - y^{\frac{1}{3}}}{y - x^{\frac{2}{3}}}$.

- A. $2\frac{1}{5}$
- B. 1
- C. $\frac{5}{11}$
- D. $\frac{11}{43}$

12. Which of the following lines represents the solution of the inequality $7x < 9x - 4$?

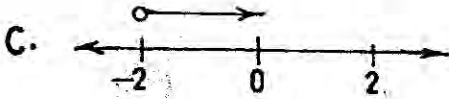
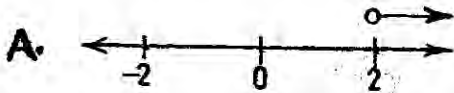

13. If $\frac{1}{2}x + 2y = 3$ and $\frac{3}{2}x - 2y = 1$, find $(x + y)$.

- A. 3
- B. 2
- C. 1
- D. 0

14. Given that $p^{\frac{1}{3}} = \frac{\sqrt[3]{q}}{r}$, make q the subject of the equation.

- A. $q = p\sqrt{r}$
- B. $q = p^3r$
- C. $q = pr^3$
- D. $q = pr^{\frac{1}{3}}$

15.

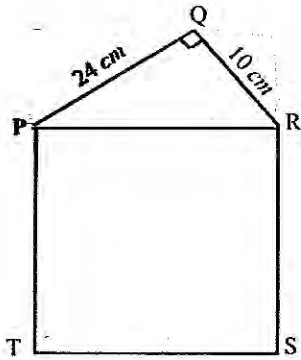

In the diagram, $PRST$ is a square. If $|PQ| = 24 \text{ cm}$, $|QR| = 10 \text{ cm}$ and $\angle PQR = 90^\circ$; find the perimeter of the polygon $PQRST$.

- A. 112 cm
- B. 98 cm
- C. 86 cm
- D. 84 cm

16.

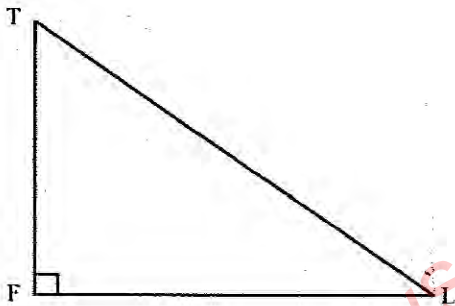

In the diagram, the height of a flagpole $|TF|$ and the length of its shadow $|FL|$ are in the ratio 6 : 8. Using K as a constant of proportionality, find the shortest distance between T and L .

- A. $7K$ units
- B. $10K$ units
- C. $12K$ units
- D. $14K$ units

17. A chord is 2 cm from the centre of a circle. If the radius of the circle is 5 cm, find the length of the chord.

- A. $2\sqrt{21}$ cm
- B. $\sqrt{42}$ cm
- C. $2\sqrt{19}$ cm
- D. $\sqrt{21}$ cm

18. A cube and a cuboid have the same base area. The volume of the cube is 64 cm^3 while that of the cuboid is 80 cm^3 . Find the height of the cuboid.
- A. 2 cm
 - B. 3 cm
 - C. 5 cm
 - D. 6 cm

$V = 64 \text{ cm}^3$
 $C = 80 \text{ cm}$

19.

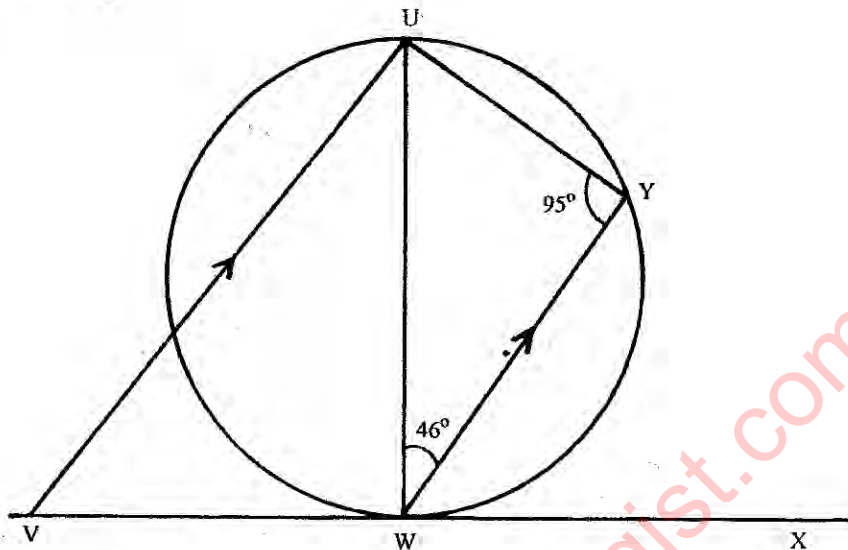

In the diagram, \overline{VX} is a tangent to the circle UYW at W . If $WY \parallel UV$, $\angle UYW = 95^\circ$ and $\angle UWY = 46^\circ$, find $\angle UVW$.

- A. 51°
- B. 49°
- C. 39°
- D. 34°

20.

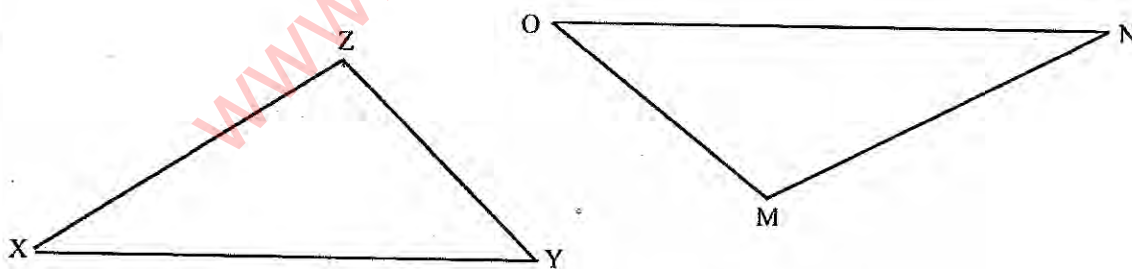

In the diagrams, $|XZ| = |MN|$, $|ZY| = |MO|$ and $|XY| = |NO|$. Which of the following statements is true?

- A. $\triangle ZYX \cong \triangle OMN$
- B. $\triangle YZX \cong \triangle NOM$
- C. $\triangle ZXY \cong \triangle MON$
- D. $\triangle XYZ \cong \triangle NOM$

21.

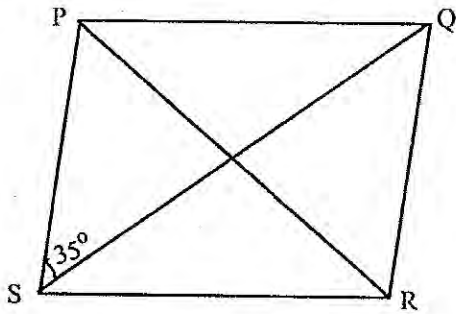

In the diagram, PQRS is a rhombus and $\angle PSQ = 35^\circ$. Calculate the size of $\angle PRQ$.

- A. 65°
- B. 55°
- C. 45°
- D. 35°

22.

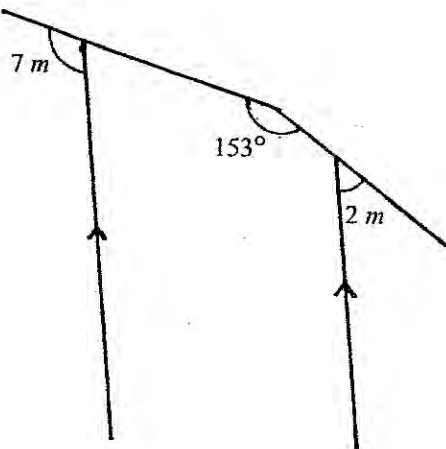

Find the value of m in the diagram.

- A. 34°
- B. 27°
- C. 23°
- D. 17°

23.

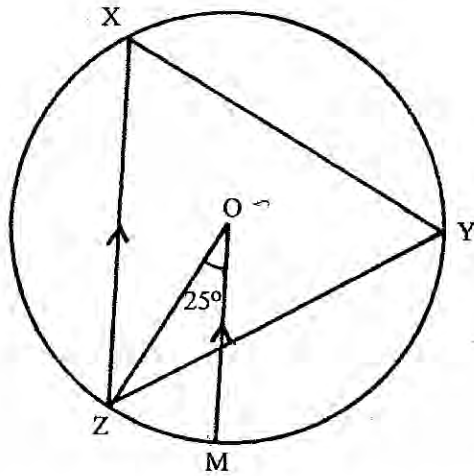

In the diagram, O is the centre of the circle, $OM \parallel XZ$ and $\angle ZOM = 25^\circ$. Calculate $\angle XYZ$.

- A. 50°
 B. 55°
 C. 60°
 D. 65°
24. If $\sin x = \frac{5}{13}$ and $0^\circ \leq x \leq 90^\circ$, find the value of $(\cos x - \tan x)$.
- A. $\frac{7}{13}$
 B. $\frac{12}{13}$
 C. $\frac{79}{156}$
 D. $\frac{209}{156}$
25. An object is 6 m away from the base of a mast. The angle of depression of the object from the top of the mast is 50° . Find, correct to 2 decimal places, the height of the mast.
- A. 8.60 m
 B. 7.51 m
 C. 7.15 m
 D. 1.19 m
26. The bearing of Y from X is 060° and the bearing of Z from $Y = 060^\circ$. Find the bearing of X from Z .
- A. 300°
 B. 240°
 C. 180°
 D. 120°

27. Which of the following is **not** a probability of Mary scoring 85% in a mathematics test?

- A. 0.15
- B. 0.57
- C. 0.94
- D. 1.01

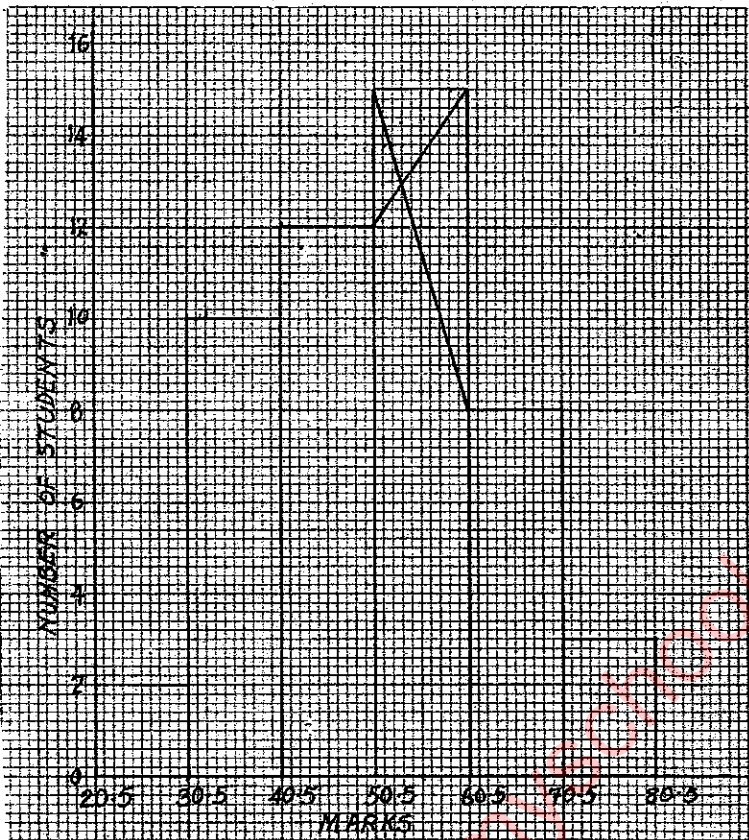

Use this histogram to answer questions 28 and 29.

28. Estimate the mode of the distribution.

- A. 51.5
- B. 52.5
- C. 53.5
- D. 54.5

29. What is the median class?

- A. 60.5 – 70.5
- B. 50.5 – 60.5
- C. 40.5 – 50.5
- D. 30.5 – 40.5

30. If $2\log_x(3\frac{3}{8}) = 6$, find the value of x .
- A. $\frac{3}{2}$
B. $\frac{4}{3}$
C. $\frac{2}{3}$
D. $\frac{1}{2}$
31. If $P = \{y: 2y \geq 6\}$ and $Q = \{y: y - 3 \leq 4\}$, where y is an integer, find $P \cap Q$.
- A. $\{3, 4\}$
B. $\{3, 7\}$
C. $\{3, 4, 5, 6, 7\}$
D. $\{4, 5, 6\}$
32. Find the values of k in the equation $6k^2 = 5k + 6$.
- A. $\left\{\frac{-2}{3}, \frac{-3}{2}\right\}$
B. $\left\{\frac{-2}{3}, \frac{3}{2}\right\}$
C. $\left\{\frac{2}{3}, \frac{-3}{2}\right\}$
D. $\left\{\frac{2}{3}, \frac{3}{2}\right\}$
33. If y varies directly as the square root of $(x + 1)$ and $y = 6$ when $x = 3$, find x when $y = 9$.
- A. 8
B. 7
C. 6
D. 5
34. The graph of the relation $y = x^2 + 2x + k$ passes through the point $(2, 0)$. Find the value of k .
- A. 0
B. -2
C. -4
D. -8

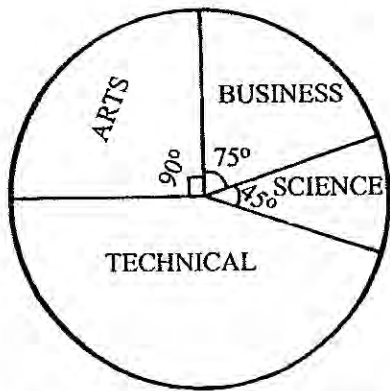

The pie chart shows the distribution of 600 mathematics textbooks for Arts, Business, Science and Technical classes. Use it to answer questions 35 and 36.

35. How many textbooks are for the Technical class?
 A. 100
 B. 150
 C. 200
 D. 250
36. What percentage of the total number of textbooks belongs to science?
 A. $12\frac{1}{2}\%$
 B. $20\frac{5}{6}\%$
 C. 25%
 D. $41\frac{2}{3}\%$

37.

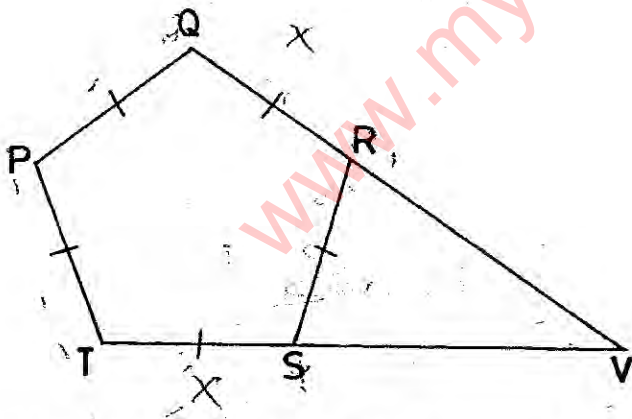

In the diagram, PQRST is a regular polygon with sides QR and TS produced to meet at V. Find the size of $\angle RVS$.

- A. 36°
 B. 54°
 C. 60°
 D. 72°

$$S_n = \frac{n(n-2)}{2} \times 180$$

$$S_5 = \frac{5(5-2)}{2} \times 180$$

$$S_5 = \frac{5 \times 3}{2} \times 180$$

$$S_5 = \frac{15}{2} \times 180$$

$$S_5 = 1350$$

$$\begin{array}{r} 5 \overline{) 1350} \\ \underline{10} \\ 35 \\ \underline{30} \\ 50 \\ \underline{50} \\ 0 \end{array}$$

$$\begin{array}{r} 36 \\ 5 \overline{) 180} \\ \underline{15} \\ 30 \end{array}$$

pentagon
 $S_n = \frac{n(n-2)}{2} \times 180$

38. What is the locus of the point X which moves relative to two fixed points P and M on a plane such that $\angle PXM = 30^\circ$?
- A. The bisector of the straight line joining P and M
 - B. An arc of a circle with \overline{PM} as a chord
 - C. The bisector of angle PXM
 - D. A circle centre X and radius PM

39.

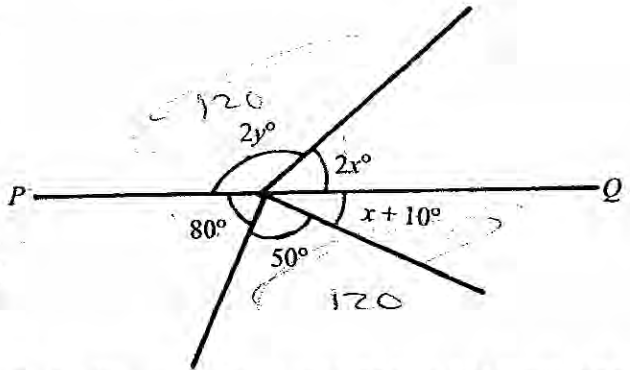

$$x + 10 + 50 = 180^\circ$$

$$x + 60 = 180^\circ$$

$$x = 120$$

$$\begin{array}{r} 50 \\ 240 \\ \hline 290 \end{array}$$

In the diagram, PQ is a straight line. Calculate the value of the angle labelled $2y$.

- A. 130°
- B. 120°
- C. 110°
- D. 100°

$$80 + 2y + 50 + 50 = 180$$

$$2y + 180 = 180$$

$$2y = 0$$

$$y = 0$$

40. When a number is subtracted from 2, the result equals 4 less than one-fifth of the number. Find the number.
- A. 11
 - B. $\frac{15}{2}$
 - C. 5
 - D. $\frac{5}{2}$

41. Express $\frac{2}{x+3} - \frac{1}{x-2}$ as a simple fraction.

A. $\frac{x-7}{x^2+x-6}$

B. $\frac{x-1}{x^2+x-6}$

C. $\frac{x-2}{x^2+x-6}$

D. $\frac{x+7}{x^2+x-6}$

42. An interior angle of a regular polygon is 5 times each exterior angle. How many sides has the polygon?

- A. 15
- B. 12
- C. 9
- D. 6

90°
180°
360°

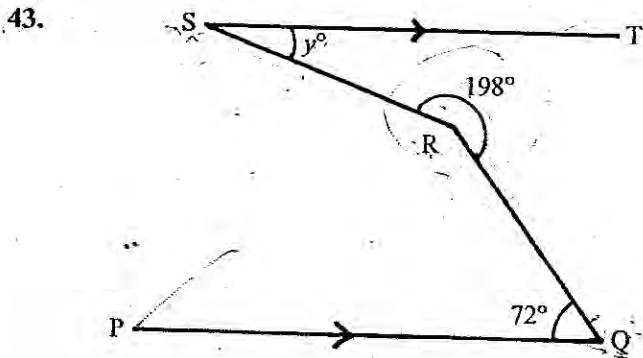

In the diagram, $\overline{ST} \parallel \overline{PQ}$, reflex angle $\widehat{SRQ} = 198^\circ$ and $\angle RQP = 72^\circ$. Find the value of y .

- A. 18°
- B. 54°
- C. 92°
- D. 108°

~~Z ⊗ Y~~
180
-72
108
360
-72

90
-72
180
90°
-72°
18°

∠A
∠Z MZ

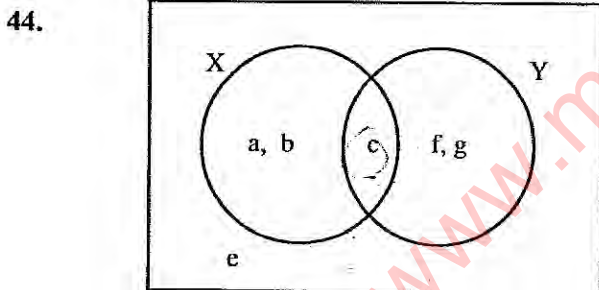

$\angle Y + 72^\circ = 90^\circ$
 $\angle Y = 90^\circ - 72^\circ$
 $\angle Y = 18^\circ$

Using the Venn diagram, find $n(X \cap Y')$.

- A. 2
- B. 3
- C. 4
- D. 6

n u U n

A B C
1 2 3

45. Given that $P = x^2 + 4x - 2$, $Q = 2x - 1$ and $Q - P = 2$, find x .
- A. -2
B. -1
C. 1
D. 2
46. A pyramid has a rectangular base with dimensions 12 m by 8 m . If its height is 14 m , calculate the volume.
- A. 344 m^3
B. 448 m^3
C. 632 m^3
D. 840 m^3
47. The slant height of a cone is 5 cm and the radius of its base is 3 cm . Find, correct to the nearest whole number, the volume of the cone. [Take $\pi = \frac{22}{7}$].
- A. 48 cm^3
B. 47 cm^3
C. 38 cm^3
D. 13 cm^3
48. The distance between two towns is 50 km . It is represented on a map by 5 cm . Find the scale used.
- A. $1 : 1,000,000$
B. $1 : 500,000$
C. $1 : 100,000$
D. $1 : 10,000$
49. Given that $(x + 2)(x^2 - 3x + 2) + 2(x + 2)(x - 1) = (x + 2)M$, find M .
- A. $(x + 2)^2$
B. $x(x + 2)$
C. $x^2 + 2$
D. $x^2 - x$
50. An open cone with base radius 28 cm and perpendicular height 96 cm was stretched to form a sector of a circle. Calculate the area of the sector. [Take $\pi = \frac{22}{7}$].
- A. 8800 cm^2
B. 8448 cm^2
C. 4400 cm^2
D. 4224 cm^2